

MC74AC161, MC74ACT161, MC74AC163, MC74ACT163

Synchronous Presetable Binary Counter

The MC74AC161/74ACT161 and MC74AC163/74ACT163 are high-speed synchronous modulo-16 binary counters. They are synchronously presetable for application in programmable dividers and have two types of Count Enable inputs plus a Terminal Count output for versatility in forming synchronous multistage counters.

The MC74AC161/74ACT161 has an asynchronous Master Reset input that overrides all other inputs and forces the outputs LOW. The MC74AC163/74ACT163 has a Synchronous Reset input that overrides counting and parallel loading and allows the outputs to be simultaneously reset on the rising edge of the clock.

- Synchronous Counting and Loading
- High-Speed Synchronous Expansion
- Typical Count Rate of 125 MHz
- Outputs Source/Sink 24 mA
- 'ACT161 and 'ACT163 Have TTL Compatible Inputs
- **These devices are available in Pb-free package(s). Specifications herein apply to both standard and Pb-free devices. Please see our website at www.onsemi.com for specific Pb-free orderable part numbers, or contact your local ON Semiconductor sales office or representative.**

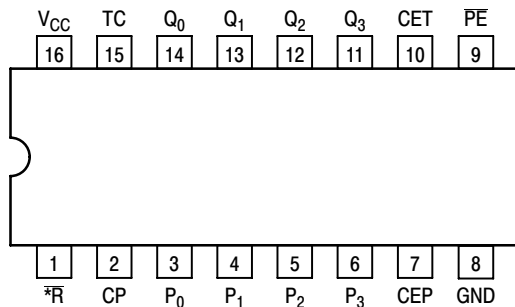

Figure 1. Pinout: 16-Lead Packages Conductors
(Top View)

PIN ASSIGNMENT

PIN	FUNCTION
CEP	Count Enable Parallel Input
CET	Count Enable Trickle Input
CP	Clock Pulse Input
MR	('161) Asynchronous Master Reset Input
SR	('163) Synchronous Reset Input
P ₀ -P ₃	Parallel Data Inputs
PE	Parallel Enable Input
Q ₀ -Q ₃	Flip-Flop Outputs
TC	Terminal Count Output



ON Semiconductor®

<http://onsemi.com>

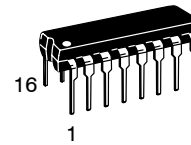

**DIP-16
N SUFFIX
CASE 648**

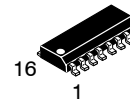

**SO-16
D SUFFIX
CASE 751B**

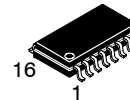

**EIAJ-16
M SUFFIX
CASE 966**

ORDERING INFORMATION

See detailed ordering and shipping information in the package dimensions section on page 12 of this data sheet.

DEVICE MARKING INFORMATION

See general marking information in the device marking section on page 11 of this data sheet.

MC74AC161, MC74ACT161, MC74AC163, MC74ACT163

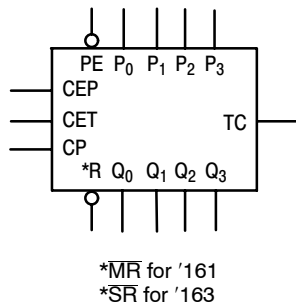

Figure 2. Logic Symbol

FUNCTIONAL DESCRIPTION

The MC74AC161/ACT161 and MC74AC163/ACT163 count modulo-16 binary sequence. From state 15 (HHHH) they increment to state 0 (LLLL). The clock inputs of all flip-flops are driven in parallel through a clock buffer. Thus all changes of the Q outputs (except due to Master Reset of the '161) occur as a result of, and synchronous with, the LOW-to-HIGH transition of the CP input signal. The circuits have four fundamental modes of operation, in order of precedence: asynchronous reset ('161), synchronous reset ('163), parallel load, count-up and hold. Five control inputs – Master Reset (\overline{MR} , '161), Synchronous Reset (\overline{SR} , '163), Parallel Enable (\overline{PE}), Count Enable Parallel (CEP) and Count Enable Trickle (CET) – determine the mode of

operation, as shown in the Mode Select Table. A LOW signal on \overline{MR} overrides all other inputs and asynchronously forces all outputs LOW. A LOW signal on \overline{SR} overrides counting and parallel loading and allows all outputs to go LOW on the next rising edge of CP. A LOW signal on \overline{PE} overrides counting and allows information on the Parallel Data (P_n) inputs to be loaded into the flip-flops on the next rising edge of CP. With \overline{PE} and \overline{MR} ('161) or \overline{SR} ('163) HIGH, CEP and CET permit counting when both are HIGH. Conversely, a LOW signal on either CEP or CET inhibits counting.

The MC74AC161/ACT161 and MC74AC163/ACT163 use D-type edge-triggered flip-flops and changing the \overline{SR} , \overline{PE} , CEP and CET inputs when the CP is in either state does not cause errors, provided that the recommended setup and hold times, with respect to the rising edge of CP, are observed.

The Terminal Count (TC) output is HIGH when CET is HIGH and counter is in state 15. To implement synchronous multistage counters, the TC outputs can be used with the CEP and CET inputs in two different ways. Please refer to the MC74AC568 data sheet. The TC output is subject to decoding spikes due to internal race conditions and is therefore not recommended for use as a clock or asynchronous reset for flip-flops, counters or registers.

Logic Equations:

$$\text{Count Enable} = \text{CEP} \cdot \text{CET} \cdot \overline{\text{PE}}$$

$$\text{TC} = Q_0 \cdot Q_1 \cdot Q_2 \cdot Q_3 \cdot \text{CET}$$

MODE SELECT TABLE

* \overline{SR}	\overline{PE}	CET	CEP	Action on the Rising Clock Edge ()
L	X	X	X	Reset (Clear)
H	L	X	X	Load ($P_n \rightarrow Q_n$)
H	H	H	H	Count (Increment)
H	H	L	X	No Change (Hold)
H	H	X	L	No Change (Hold)

*For '163 only

H = HIGH Voltage Level

L = LOW Voltage Level

X = Immaterial

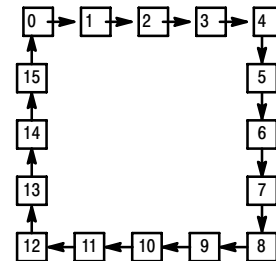
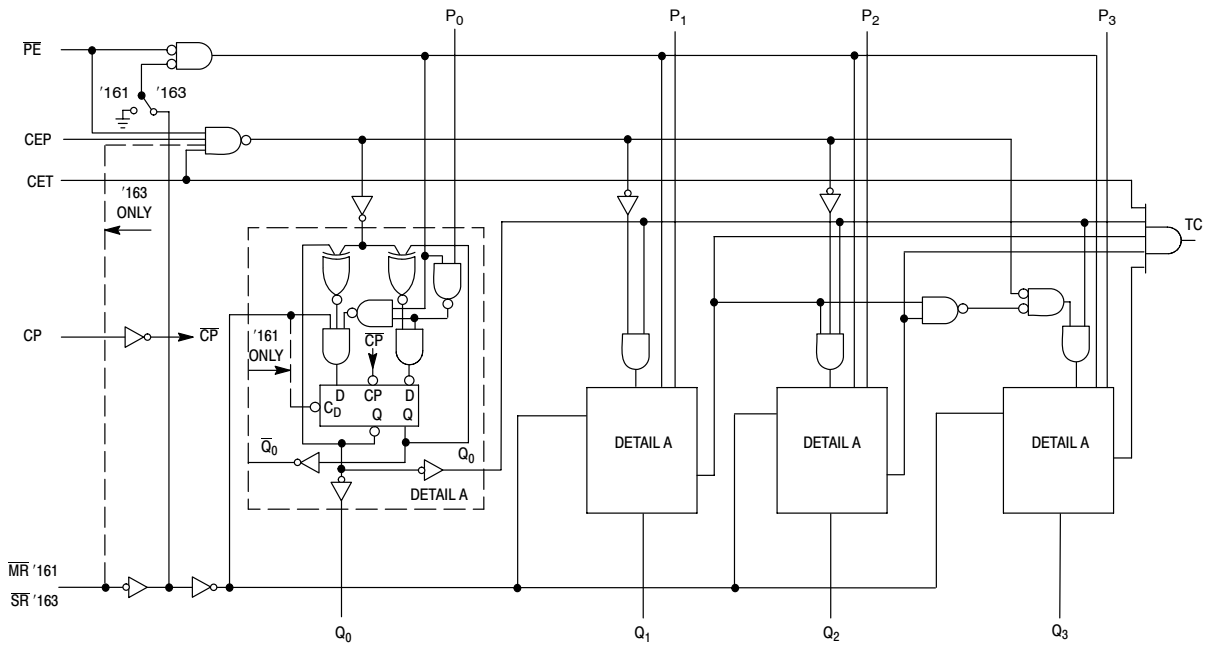

Figure 3. State Diagram

MC74AC161, MC74ACT161, MC74AC163, MC74ACT163



NOTE: This diagram is provided only for the understanding of logic operations and should not be used to estimate propagation delays.

Figure 4. Logic Diagram

MAXIMUM RATINGS*

Symbol	Parameter	Value	Unit
V_{CC}	DC Supply Voltage (Referenced to GND)	-0.5 to +7.0	V
V_{IN}	DC Input Voltage (Referenced to GND)	-0.5 to $V_{CC} + 0.5$	V
V_{OUT}	DC Output Voltage (Referenced to GND)	-0.5 to $V_{CC} + 0.5$	V
I_{IN}	DC Input Current, per Pin	± 20	mA
I_{OUT}	DC Output Sink/Source Current, per Pin	± 50	mA
I_{CC}	DC V_{CC} or GND Current per Output Pin	± 50	mA
T_{stg}	Storage Temperature	-65 to +150	$^{\circ}C$

*Maximum Ratings are those values beyond which damage to the device may occur. Functional operation should be restricted to the Recommended Operating Conditions.

MC74AC161, MC74ACT161, MC74AC163, MC74ACT163

RECOMMENDED OPERATING CONDITIONS

Symbol	Parameter	Min	Typ	Max	Unit	
V _{CC}	Supply Voltage	'AC	2.0	5.0	6.0	V
		'ACT	4.5	5.0	5.5	
V _{IN} , V _{OUT}	DC Input Voltage, Output Voltage (Ref. to GND)	0	–	V _{CC}	V	
t _r , t _f	Input Rise and Fall Time (Note 1) 'AC Devices except Schmitt Inputs	V _{CC} @ 3.0 V	–	150	–	ns/V
		V _{CC} @ 4.5 V	–	40	–	
		V _{CC} @ 5.5 V	–	25	–	
t _r , t _f	Input Rise and Fall Time (Note 2) 'ACT Devices except Schmitt Inputs	V _{CC} @ 4.5 V	–	10	–	ns/V
		V _{CC} @ 5.5 V	–	8.0	–	
T _J	Junction Temperature (PDIP)	–	–	140	°C	
T _A	Operating Ambient Temperature Range	–40	25	85	°C	
I _{OH}	Output Current – High	–	–	–24	mA	
I _{OL}	Output Current – Low	–	–	24	mA	

- V_{IN} from 30% to 70% V_{CC}; see individual Data Sheets for devices that differ from the typical input rise and fall times.
- V_{IN} from 0.8 V to 2.0 V; see individual Data Sheets for devices that differ from the typical input rise and fall times.

DC CHARACTERISTICS

Symbol	Parameter	V _{CC} (V)	74AC		74ACT	Unit	Conditions	
			T _A = +25°C		T _A = –40°C to +85°C			
			Typ	Guaranteed Limits				
V _{IH}	Minimum High Level Input Voltage	3.0	1.5	2.1	2.1	V	V _{OUT} = 0.1 V or V _{CC} – 0.1 V	
		4.5	2.25	3.15	3.15			
		5.5	2.75	3.85	3.85			
V _{IL}	Maximum Low Level Input Voltage	3.0	1.5	0.9	0.9	V	V _{OUT} = 0.1 V or V _{CC} – 0.1 V	
		4.5	2.25	1.35	1.35			
		5.5	2.75	1.65	1.65			
V _{OH}	Minimum High Level Output Voltage	3.0	2.99	2.9	2.9	V	I _{OUT} = –50 μA	
		4.5	4.49	4.4	4.4			
		5.5	5.49	5.4	5.4			
			3.0	–	2.56	2.46	V	*V _{IN} = V _{IL} or V _{IH} –12 mA I _{OH} –24 mA –24 mA
			4.5	–	3.86	3.76		
			5.5	–	4.86	4.76		
V _{OL}	Maximum Low Level Output Voltage	3.0	0.002	0.1	0.1	V	I _{OUT} = 50 μA	
		4.5	0.001	0.1	0.1			
		5.5	0.001	0.1	0.1			
			3.0	–	0.36	0.44	V	*V _{IN} = V _{IL} or V _{IH} 12 mA I _{OL} 24 mA 24 mA
			4.5	–	0.36	0.44		
			5.5	–	0.36	0.44		
I _{IN}	Maximum Input Leakage Current	5.5	–	±0.1	±1.0	μA	V _I = V _{CC} , GND	
I _{OLD}	†Minimum Dynamic Output Current	5.5	–	–	75	mA	V _{OLD} = 1.65 V Max	
I _{OHD}		5.5	–	–	–75	mA	V _{OHD} = 3.85 V Min	
I _{CC}	Maximum Quiescent Supply Current	5.5	–	8.0	80	μA	V _{IN} = V _{CC} or GND	

*All outputs loaded; thresholds on input associated with output under test.

†Maximum test duration 2.0 ms, one output loaded at a time.

NOTE: I_{IN} and I_{CC} @ 3.0 V are guaranteed to be less than or equal to the respective limit @ 5.5 V V_{CC}.

MC74AC161, MC74ACT161, MC74AC163, MC74ACT163

AC CHARACTERISTICS (For Figures and Waveforms – See Section 3 of the ON Semiconductor FACT Data Book, DL138/D)

Symbol	Parameter	V _{CC} * (V)	74AC161			74AC161		Unit	Fig. No.
			T _A = +25°C C _L = 50 pF			T _A = -40°C to +85°C C _L = 50 pF			
			Min	Typ	Max	Min	Max		
f _{max}	Maximum Count Frequency	3.3 5.0	70 110	111 167	– –	60 95	– –	MHz	3–3
t _{PLH}	Propagation Delay CP to Q _n (PE Input HIGH or LOW)	3.3 5.0	2.0 1.5	7.0 5.0	12.0 9.0	1.5 1.0	13.5 9.5	ns	3–6
t _{PHL}	Propagation Delay CP to Q _n (PE Input HIGH or LOW)	3.3 5.0	1.5 1.5	7.0 5.0	12.0 9.5	1.5 1.5	13.0 10.0	ns	3–6
t _{PLH}	Propagation Delay CP to TC	3.3 5.0	3.0 2.0	9.0 6.0	15.0 10.5	2.5 1.5	16.5 11.5	ns	3–6
t _{PHL}	Propagation Delay CP to TC	3.3 5.0	3.5 2.0	8.5 6.5	14.0 11.0	2.5 2.0	15.5 11.5	ns	3–6
t _{PLH}	Propagation Delay CET to TC	3.3 5.0	2.0 1.5	5.5 3.5	9.5 6.5	1.5 1.0	11.0 7.5	ns	3–6
t _{PHL}	Propagation Delay CET to TC	3.3 5.0	2.5 2.0	6.5 5.0	11.0 8.5	2.0 1.5	12.5 9.5	ns	3–6
t _{PHL}	Propagation Delay MR to Q _n	3.3 5.0	2.0 1.5	6.0 5.5	12.0 9.5	1.5 1.5	13.5 10.0	ns	3–6
t _{PHL}	Propagation Delay MR to TC	3.3 5.0	3.5 2.5	10.0 8.5	15.0 13.0	3.0 2.5	17.5 13.5	ns	3–6

*Voltage Range 3.3 V is 3.3 V ±0.3 V.

*Voltage Range 5.0 V is 5.0 V ±0.5 V.

AC CHARACTERISTICS (For Figures and Waveforms – See Section 3 of the ON Semiconductor FACT Data Book, DL138/D)

Symbol	Parameter	V _{CC} * (V)	74AC163			74AC163		Unit	Fig. No.
			T _A = +25°C C _L = 50 pF			T _A = -40°C to +85°C C _L = 50 pF			
			Min	Typ	Max	Min	Max		
f _{max}	Maximum Count Frequency	3.3 5.0	70 110	95 140	– –	60 95	– –	MHz	3–3
t _{PLH}	Propagation Delay CP to Q _n (PE Input HIGH or LOW)	3.3 5.0	2.0 1.5	7.5 5.5	12.5 9.0	1.5 1.0	13.5 9.5	ns	3–6
t _{PHL}	Propagation Delay CP to Q _n (PE Input HIGH or LOW)	3.3 5.0	1.5 1.5	8.5 6.0	12.0 9.5	1.5 1.5	13.0 10.0	ns	3–6
t _{PLH}	Propagation Delay CP to TC	3.3 5.0	3.0 2.0	9.5 7.0	15.0 10.5	2.5 1.5	16.5 11.5	ns	3–6
t _{PHL}	Propagation Delay CP to TC	3.3 5.0	3.5 2.0	11.0 8.0	14.0 11.0	2.5 2.0	15.5 11.5	ns	3–6
t _{PLH}	Propagation Delay CET to TC	3.3 5.0	2.0 1.5	7.5 5.5	9.5 6.5	1.5 1.0	11.0 7.5	ns	3–6
t _{PHL}	Propagation Delay CET to TC	3.3 5.0	2.5 2.0	8.5 6.0	11.0 8.5	2.0 1.5	12.5 9.5	ns	3–6

*Voltage Range 3.3 V is 3.3 V ±0.3 V.

*Voltage Range 5.0 V is 5.0 V ±0.5 V.

MC74AC161, MC74ACT161, MC74AC163, MC74ACT163

AC OPERATING REQUIREMENTS

Symbol	Parameter	V _{CC} * (V)	74AC161		74ACT161		Unit	Fig. No.
			T _A = +25°C C _L = 50 pF		T _A = -40°C to +85°C C _L = 50 pF			
			Typ	Guaranteed Minimum				
t _s	Setup Time, HIGH or LOW P _n to CP	3.3	6.0	13.5	16.0	ns	3-9	
		5.0	3.5	8.5	10.5			
t _h	Hold Time, HIGH or LOW P _n to CP	3.3	-7.0	-1.0	-0.5	ns	3-9	
		5.0	-4.0	0	0			
t _s	Setup Time, HIGH or LOW PE to CP	3.3	6.5	11.5	14.0	ns	3-9	
		5.0	4.0	7.5	8.5			
t _h	Hold Time, HIGH or LOW PE to CP	3.3	-6.0	0	0	ns	3-9	
		5.0	-3.5	0.5	1.0			
t _s	Setup Time, HIGH or LOW CEP or CET to CP	3.3	3.0	6.0	7.0	ns	3-9	
		5.0	2.0	4.5	5.0			
t _h	Hold Time, HIGH or LOW CEP or CET to CP	3.3	-3.5	0	0	ns	3-9	
		5.0	-2.0	0	0.5			
t _w	Clock Pulse Width (Load) HIGH or LOW	3.3	2.0	3.5	4.0	ns	3-6	
		5.0	2.0	2.5	3.0			
t _w	Clock Pulse Width (Count) HIGH or LOW	3.3	2.0	4.0	4.5	ns	3-6	
		5.0	2.0	3.0	3.5			
t _w	MR Pulse Width, LOW	3.3	3.0	5.5	7.5	ns	3-6	
		5.0	2.5	4.5	6.0			
t _{rec}	Recovery Time MR to CP	3.3	-2.0	-0.5	0	ns	3-9	
		5.0	-1.0	0	0.5			

*Voltage Range 3.3 V is 3.3 V ±0.3 V.

*Voltage Range 5.0 V is 5.0 V ±0.5 V.

MC74AC161, MC74ACT161, MC74AC163, MC74ACT163

AC OPERATING REQUIREMENTS

Symbol	Parameter	V _{CC} * (V)	74AC163		74ACT163		Unit	Fig. No.
			T _A = +25°C C _L = 50 pF		T _A = -40°C to +85°C C _L = 50 pF			
			Typ	Guaranteed Minimum				
t _s	Setup Time, HIGH or LOW P _n to CP	3.3	5.5	13.5	16.0	ns	3-9	
		5.0	4.0	8.5	10.5			
t _h	Hold Time, HIGH or LOW P _n to CP	3.3	-7.0	-1.0	-0.5	ns	3-9	
		5.0	-5.0	0	0			
t _s	Setup Time, HIGH or LOW SR to CP	3.3	5.5	14	16.5	ns	3-9	
		5.0	4.0	9.5	11.0			
t _h	Hold Time, HIGH or LOW SR to CP	3.3	-7.5	-1.0	-0.5	ns	3-9	
		5.0	-5.5	-0.5	0			
t _s	Setup Time, HIGH or LOW PE to CP	3.3	5.5	11.5	14.0	ns	3-9	
		5.0	4.0	7.5	8.5			
t _h	Hold Time, HIGH or LOW PE to CP	3.3	-7.5	-1.0	-0.5	ns	3-9	
		5.0	-5.0	-0.5	0			
t _s	Setup Time, HIGH or LOW CEP or CET to CP	3.3	3.5	6.0	7.0	ns	3-9	
		5.0	2.5	4.5	5.0			
t _h	Hold Time, HIGH or LOW CEP or CET to CP	3.3	-4.5	0	0	ns	3-9	
		5.0	-3.0	0	0.5			
t _w	Clock Pulse Width (Load) HIGH or LOW	3.3	3.0	3.5	4.0	ns	3-6	
		5.0	2.0	2.5	3.0			
t _w	Clock Pulse Width (Count) HIGH or LOW	3.3	3.0	4.0	4.5	ns	3-6	
		5.0	2.0	3.0	3.5			

*Voltage Range 3.3 V is 3.3 V ±0.3 V.

*Voltage Range 5.0 V is 5.0 V ±0.5 V.

MC74AC161, MC74ACT161, MC74AC163, MC74ACT163

DC CHARACTERISTICS

Symbol	Parameter	V _{CC} (V)	74ACT		74ACT		Unit	Conditions
			T _A = +25°C		T _A = -40°C to +85°C			
			Typ	Guaranteed Limits				
V _{IH}	Minimum High Level Input Voltage	4.5	1.5	2.0	2.0	V	V _{OUT} = 0.1 V or V _{CC} - 0.1 V	
		5.5	1.5	2.0	2.0			
V _{IL}	Maximum Low Level Input Voltage	4.5	1.5	0.8	0.8	V	V _{OUT} = 0.1 V or V _{CC} - 0.1 V	
		5.5	1.5	0.8	0.8			
V _{OH}	Minimum High Level Output Voltage	4.5	4.49	4.4	4.4	V	I _{OUT} = -50 μA	
		5.5	5.49	5.4	5.4			
		4.5	-	3.86	3.76	V	*V _{IN} = V _{IL} or V _{IH} I _{OH} = -24 mA	
		5.5	-	4.86	4.76			
V _{OL}	Maximum Low Level Output Voltage	4.5	0.001	0.1	0.1	V	I _{OUT} = 50 μA	
		5.5	0.001	0.1	0.1			
		4.5	-	0.36	0.44	V	*V _{IN} = V _{IL} or V _{IH} I _{OL} = 24 mA	
		5.5	-	0.36	0.44			
I _{IN}	Maximum Input Leakage Current	5.5	-	±0.1	±1.0	μA	V _I = V _{CC} , GND	
ΔI _{CCT}	Additional Max. I _{CC} /Input	5.5	0.6	-	1.5	mA	V _I = V _{CC} - 2.1 V	
I _{OLD}	†Minimum Dynamic Output Current	5.5	-	-	75	mA	V _{OLD} = 1.65 V Max	
I _{OHD}		5.5	-	-	-75	mA	V _{OHD} = 3.85 V Min	
I _{CC}	Maximum Quiescent Supply Current	5.5	-	8.0	80	μA	V _{IN} = V _{CC} or GND	

*All outputs loaded; thresholds on input associated with output under test.

†Maximum test duration 2.0 ms, one output loaded at a time.

MC74AC161, MC74ACT161, MC74AC163, MC74ACT163

AC CHARACTERISTICS (For Figures and Waveforms – See Section 3 of the ON Semiconductor FACT Data Book, DL138/D)

Symbol	Parameter	V _{CC} * (V)	74ACT161			74ACT161		Unit	Fig. No.
			T _A = +25°C C _L = 50 pF			T _A = –40°C to +85°C C _L = 50 pF			
			Min	Typ	Max	Min	Max		
f _{max}	Maximum Count Frequency	5.0	115	125	–	100	–	MHz	3–3
t _{PLH}	Propagation Delay CP to Q _n (\overline{PE} Input HIGH or LOW)	5.0	1.5	8.0	9.5	1.5	10.5	ns	3–6
t _{PHL}	Propagation Delay CP or Q _n (\overline{PE} Input HIGH or LOW)	5.0	1.5	8.0	10.5	1.5	11.5	ns	3–6
t _{PLH}	Propagation Delay CP to TC	5.0	2.0	11.0	11.0	1.5	12.5	ns	3–6
t _{PHL}	Propagation Delay CP to TC	5.0	1.5	11.0	12.5	1.5	13.5	ns	3–6
t _{PLH}	Propagation Delay CET to TC	5.0	1.5	7.5	8.5	1.5	10.0	ns	3–6
t _{PHL}	Propagation Delay CET to TC	5.0	1.5	8.0	9.5	1.5	10.5	ns	3–6
t _{PHL}	Propagation Delay \overline{MR} to Q _n	5.0	1.5	8.0	10.0	1.5	11.0	ns	3–6
t _{PHL}	Propagation Delay \overline{MR} to TC	5.0	2.5	10.0	13.5	2.0	14.5	ns	3–6

*Voltage Range 5.0 V is 5.0 V ±0.5 V.

AC CHARACTERISTICS (For Figures and Waveforms – See Section 3 of the ON Semiconductor FACT Data Book, DL138/D)

Symbol	Parameter	V _{CC} * (V)	74ACT163			74ACT163		Unit	Fig. No.
			T _A = +25°C C _L = 50 pF			T _A = –40°C to +85°C C _L = 50 pF			
			Min	Typ	Max	Min	Max		
f _{max}	Maximum Count Frequency	5.0	120	140	–	105	–	MHz	3–3
t _{PLH}	Propagation Delay CP to Q _n (\overline{PE} Input HIGH or LOW)	5.0	1.5	5.5	10.0	1.5	11.0	ns	3–6
t _{PHL}	Propagation Delay CP to Q _n (\overline{PE} Input HIGH or LOW)	5.0	1.5	6.0	11.0	1.5	12.0	ns	3–6
t _{PLH}	Propagation Delay CP to TC	5.0	2.5	7.0	11.5	2.0	13.5	ns	3–6
t _{PHL}	Propagation Delay CP to TC	5.0	3.0	8.0	13.5	2.0	15.0	ns	3–6
t _{PLH}	Propagation Delay CET to TC	5.0	2.0	5.5	9.0	1.5	10.5	ns	3–6
t _{PHL}	Propagation Delay CET to TC	5.0	2.0	6.0	10.0	2.0	11.0	ns	3–6

*Voltage Range 5.0 V is 5.0 V ±0.5 V.

MC74AC161, MC74ACT161, MC74AC163, MC74ACT163

AC OPERATING REQUIREMENTS

Symbol	Parameter	V _{CC} * (V)	74ACT161		74ACT161		Unit	Fig. No.
			T _A = +25°C C _L = 50 pF		T _A = -40°C to +85°C C _L = 50 pF			
			Typ	Guaranteed Minimum				
t _s	Setup Time, HIGH or LOW P _n to CP	5.0	7.0	9.5	11.5	ns	3-9	
t _h	Hold Time, HIGH or LOW P _n to CP	5.0	-3.0	0	0	ns	3-9	
t _s	Setup Time, HIGH or LOW PE to CP	5.0	6.0	8.5	9.5	ns	3-9	
t _h	Hold Time, HIGH or LOW PE to CP	5.0	-3.5	-0.5	-0.5	ns	3-9	
t _s	Setup Time, HIGH or LOW CEP or CET to CP	5.0	4.0	5.5	6.5	ns	3-9	
t _h	Hold Time, HIGH or LOW CEP or CET to CP	5.0	-2.0	0	0	ns	3-9	
t _w	Clock Pulse Width (Load) HIGH or LOW	5.0	2.0	3.0	3.5	ns	3-6	
t _w	Clock Pulse Width (Count) HIGH or LOW	5.0	2.0	3.0	3.5	ns	3-6	
t _w	M _R Pulse Width, LOW	5.0	3.0	3.0	7.5	ns	3-6	
t _{rec}	Recovery Time M _R to CP	5.0	0	0	0.5	ns	3-9	

*Voltage Range 5.0 V is 5.0 V ±0.5 V.

MC74AC161, MC74ACT161, MC74AC163, MC74ACT163

AC OPERATING REQUIREMENTS

Symbol	Parameter	V _{CC} * (V)	74ACT163		74ACT163		Unit	Fig. No.
			T _A = +25°C C _L = 50 pF		T _A = -40°C to +85°C C _L = 50 pF			
			Typ	Guaranteed Minimum				
t _s	Setup Time, HIGH or LOW P _n to CP	5.0	4.0	10.0	12.0	ns	3-9	
t _h	Hold Time, HIGH or LOW P _n to CP	5.0	-5.0	0.5	0.5	ns	3-9	
t _s	Setup Time, HIGH or LOW SR to CP	5.0	4.0	10.0	11.5	ns	3-9	
t _h	Hold Time, HIGH or LOW SR to CP	5.0	-5.5	-0.5	-0.5	ns	3-9	
t _s	Setup Time, HIGH or LOW PE to CP	5.0	4.0	8.5	10.5	ns	3-9	
t _h	Hold Time, HIGH or LOW PE to CP	5.0	-5.5	-0.5	0	ns	3-9	
t _s	Setup Time, HIGH or LOW CEP or CET to CP	5.0	2.5	5.5	6.5	ns	3-9	
t _h	Hold Time, HIGH or LOW CEP or CET to CP	5.0	-3.0	0	0.5	ns	3-9	
t _w	Clock Pulse Width HIGH or LOW	5.0	2.0	3.5	3.5	ns	3-6	
t _w	Clock Pulse Width (Count) HIGH or LOW	5.0	2.0	3.5	3.5	ns	3-6	

*Voltage Range 5.0 V is 5.0 V ±0.5 V.

CAPACITANCE

Symbol	Parameter	Value Typ	Unit	Test Conditions
C _{IN}	Input Capacitance	4.5	pF	V _{CC} = 5.0 V
C _{PD}	Power Dissipation Capacitance	45	pF	V _{CC} = 5.0 V

MARKING DIAGRAMS

DIP-16



SO-16



EIAJ-16

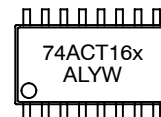
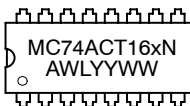
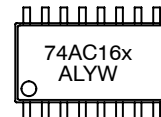

x = 1 or 3
A = Assembly Location
WL, L = Wafer Lot
YY, Y = Year
WW, W = Work Week

MC74AC161, MC74ACT161, MC74AC163, MC74ACT163

ORDERING INFORMATION

Device	Package	Shipping
MC74AC161N	PDIP-16	25 Units/Rail
MC74ACT161N	PDIP-16	25 Units/Rail
MC74AC161D	SOIC-16	48 Units/Rail
MC74AC161DR2	SOIC-16	2500 Tape & Reel
MC74ACT161D	SOIC-16	48 Units/Rail
MC74ACT161DR2	SOIC-16	2500 Tape & Reel
MC74AC161M	EIAJ-16	50 Units/Rail
MC74ACT161MEL	EIAJ-16	2000 Tape & Reel
MC74AC163N	PDIP-16	25 Units/Rail
MC74ACT163N	PDIP-16	25 Units/Rail
MC74AC163D	SOIC-16	48 Units/Rail
MC74AC163DR2	SOIC-16	2500 Tape & Reel
MC74ACT163D	SOIC-16	48 Units/Rail
MC74ACT163DR2	SOIC-16	2500 Tape & Reel
MC74AC163MEL	EIAJ-16	2000 Tape & Reel
MC74ACT163MEL	EIAJ-16	2000 Tape & Reel

MC74AC161, MC74ACT161, MC74AC163, MC74ACT163

PACKAGE DIMENSIONS

PDIP-16 N SUFFIX 16 PIN PLASTIC DIP PACKAGE CASE 648-08 ISSUE R

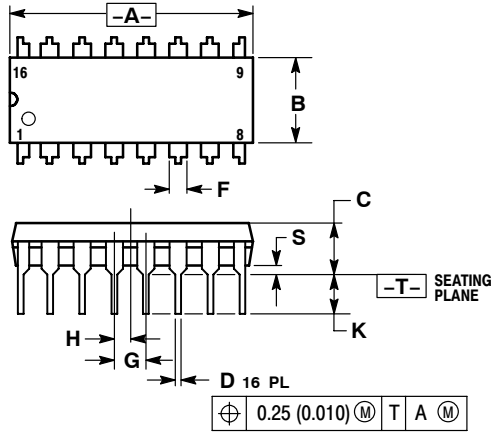

NOTES:

1. DIMENSIONING AND TOLERANCING PER ANSI Y14.5M, 1982.
2. CONTROLLING DIMENSION: INCH.
3. DIMENSION L TO CENTER OF LEADS WHEN FORMED PARALLEL.
4. DIMENSION B DOES NOT INCLUDE MOLD FLASH.
5. ROUNDED CORNERS OPTIONAL.

DIM	INCHES		MILLIMETERS	
	MIN	MAX	MIN	MAX
A	0.740	0.770	18.80	19.55
B	0.250	0.270	6.35	6.85
C	0.145	0.175	3.69	4.44
D	0.015	0.021	0.39	0.53
F	0.040	0.70	1.02	1.77
G	0.100 BSC		2.54 BSC	
H	0.050 BSC		1.27 BSC	
J	0.008	0.015	0.21	0.38
K	0.110	0.130	2.80	3.30
L	0.295	0.305	7.50	7.74
M	0°	10°	0°	10°
S	0.020	0.040	0.51	1.01

SO-16 D SUFFIX 16 PIN PLASTIC SOIC PACKAGE CASE 751B-05 ISSUE J

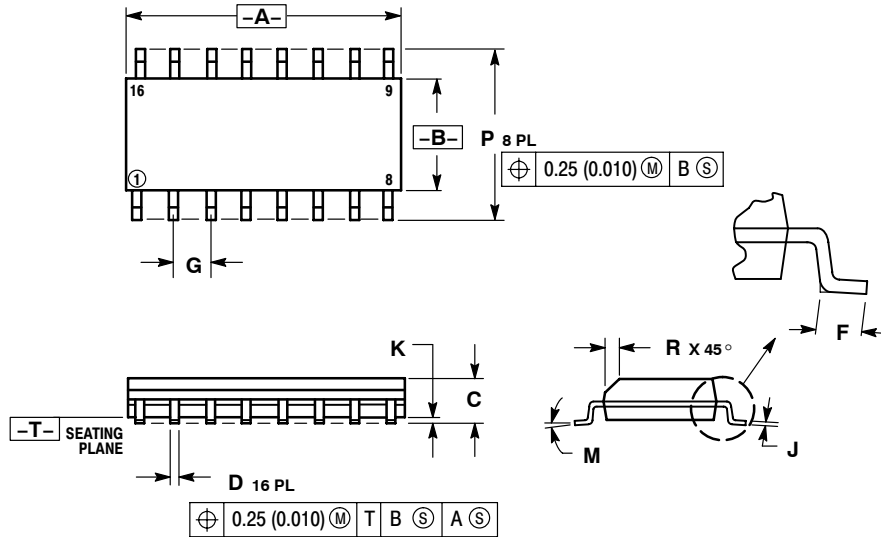

NOTES:

1. DIMENSIONING AND TOLERANCING PER ANSI Y14.5M, 1982.
2. CONTROLLING DIMENSION: MILLIMETER.
3. DIMENSIONS A AND B DO NOT INCLUDE MOLD PROTRUSION.
4. MAXIMUM MOLD PROTRUSION 0.15 (0.006) PER SIDE.
5. DIMENSION D DOES NOT INCLUDE DAMBAR PROTRUSION. ALLOWABLE DAMBAR PROTRUSION SHALL BE 0.127 (0.005) TOTAL IN EXCESS OF THE D DIMENSION AT MAXIMUM MATERIAL CONDITION.

DIM	MILLIMETERS		INCHES	
	MIN	MAX	MIN	MAX
A	9.80	10.00	0.386	0.393
B	3.80	4.00	0.150	0.157
C	1.35	1.75	0.054	0.068
D	0.35	0.49	0.014	0.019
F	0.40	1.25	0.016	0.049
G	1.27 BSC		0.050 BSC	
J	0.19	0.25	0.008	0.009
K	0.10	0.25	0.004	0.009
M	0°	7°	0°	7°
P	5.80	6.20	0.229	0.244
R	0.25	0.50	0.010	0.019

MC74AC161, MC74ACT161, MC74AC163, MC74ACT163

PACKAGE DIMENSIONS

EIAJ-16
M SUFFIX
16 PIN PLASTIC EIAJ PACKAGE
CASE966-01
ISSUE O

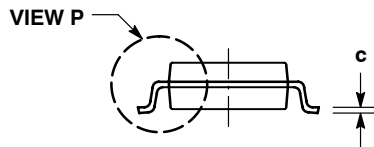
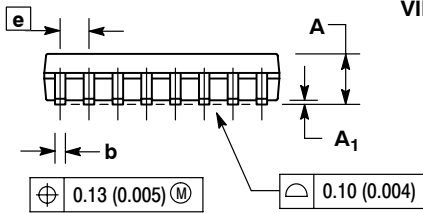
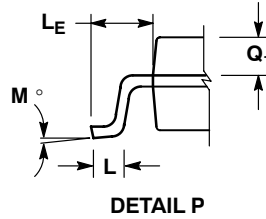
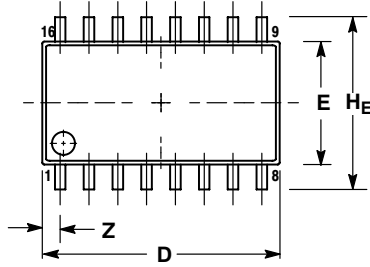

NOTES:

1. DIMENSIONING AND TOLERANCING PER ANSI Y14.5M, 1982.
2. CONTROLLING DIMENSION: MILLIMETER.
3. DIMENSIONS D AND E DO NOT INCLUDE MOLD FLASH OR PROTRUSIONS AND ARE MEASURED AT THE PARTING LINE. MOLD FLASH OR PROTRUSIONS SHALL NOT EXCEED 0.15 (0.006) PER SIDE.
4. TERMINAL NUMBERS ARE SHOWN FOR REFERENCE ONLY.
5. THE LEAD WIDTH DIMENSION (b) DOES NOT INCLUDE DAMBAR PROTRUSION. ALLOWABLE DAMBAR PROTRUSION SHALL BE 0.08 (0.003) TOTAL IN EXCESS OF THE LEAD WIDTH DIMENSION AT MAXIMUM MATERIAL CONDITION. DAMBAR CANNOT BE LOCATED ON THE LOWER RADIUS OR THE FOOT. MINIMUM SPACE BETWEEN PROTRUSIONS AND ADJACENT LEAD TO BE 0.46 (0.018).

DIM	MILLIMETERS		INCHES	
	MIN	MAX	MIN	MAX
A	---	2.05	---	0.081
A ₁	0.05	0.20	0.002	0.008
b	0.35	0.50	0.014	0.020
c	0.18	0.27	0.007	0.011
D	9.90	10.50	0.390	0.413
E	5.10	5.45	0.201	0.215
e	1.27 BSC		0.050 BSC	
H _E	7.40	8.20	0.291	0.323
L	0.50	0.85	0.020	0.033
L _E	1.10	1.50	0.043	0.059
M	0°	10°	0°	10°
Q ₁	0.70	0.90	0.028	0.035
Z	---	0.78	---	0.031

Notes

ON Semiconductor and **ON** are registered trademarks of Semiconductor Components Industries, LLC (SCILLC). SCILLC reserves the right to make changes without further notice to any products herein. SCILLC makes no warranty, representation or guarantee regarding the suitability of its products for any particular purpose, nor does SCILLC assume any liability arising out of the application or use of any product or circuit, and specifically disclaims any and all liability, including without limitation special, consequential or incidental damages. "Typical" parameters which may be provided in SCILLC data sheets and/or specifications can and do vary in different applications and actual performance may vary over time. All operating parameters, including "Typicals" must be validated for each customer application by customer's technical experts. SCILLC does not convey any license under its patent rights nor the rights of others. SCILLC products are not designed, intended, or authorized for use as components in systems intended for surgical implant into the body, or other applications intended to support or sustain life, or for any other application in which the failure of the SCILLC product could create a situation where personal injury or death may occur. Should Buyer purchase or use SCILLC products for any such unintended or unauthorized application, Buyer shall indemnify and hold SCILLC and its officers, employees, subsidiaries, affiliates, and distributors harmless against all claims, costs, damages, and expenses, and reasonable attorney fees arising out of, directly or indirectly, any claim of personal injury or death associated with such unintended or unauthorized use, even if such claim alleges that SCILLC was negligent regarding the design or manufacture of the part. SCILLC is an Equal Opportunity/Affirmative Action Employer. This literature is subject to all applicable copyright laws and is not for resale in any manner.

PUBLICATION ORDERING INFORMATION

LITERATURE FULFILLMENT:

Literature Distribution Center for ON Semiconductor
P.O. Box 61312, Phoenix, Arizona 85082-1312 USA

Phone: 480-829-7710 or 800-344-3860 Toll Free USA/Canada

Fax: 480-829-7709 or 800-344-3867 Toll Free USA/Canada

Email: orderlit@onsemi.com

N. American Technical Support: 800-282-9855 Toll Free
USA/Canada

Japan: ON Semiconductor, Japan Customer Focus Center
2-9-1 Kamimeguro, Meguro-ku, Tokyo, Japan 153-0051
Phone: 81-3-5773-3850

ON Semiconductor Website: <http://onsemi.com>

Order Literature: <http://www.onsemi.com/litorder>

For additional information, please contact your
local Sales Representative.

MC74AC161/D