

# ALMD-LL36, ALMD-LG36, ALMD-LM36, ALMD-LB36



## High Brightness SMT Oval LED Lamps

Amber, Red, Green, and Blue

### Data Sheet



#### Description

The Avago ALMD-Lx36 oval LED series has the same or just slightly less luminous intensity than conventional high brightness, through-hole LEDs.

The new oval LED lamps can be assembled using common SMT assembly processes and are compatible with industrial reflow soldering processes.

The LEDs are made with an advanced optical grade epoxy for superior performance in outdoor sign applications. The surface mount Oval LEDs are specifically designed for full color/video signs and indoor or outdoor passenger information sign applications.

For easy pick-and-place assembly, the LEDs are shipped in EIA-compliant tape and reel. Every reel is shipped from a single intensity and color bin— except the red color—for better uniformity.

**CAUTION** InGaN devices are Class 1C HBM ESD sensitive, AlInGaP devices are Class 1B ESD sensitive per JEDEC Standard. Please observe appropriate precautions during handling and processing. Refer to Application Note AN-1142 for additional details.

**CAUTION** Customer is advised to keep the LED in the MBB when not in use as prolonged exposure to environment might cause the silver plated leads to tarnish, which might cause difficulties in soldering.

#### Features

- Well-defined spatial radiation pattern
- High brightness material
- Available in Red, Amber, Green and Blue color:
  - Red AlInGaP 626 nm
  - Amber AlInGaP 590 nm
  - Green InGaN 525 nm
  - Blue InGaN 470 nm
- JEDEC MSL 2A
- Compatible with reflow soldering process
- Tinted and diffused lens
- Wide viewing angle: 40° × 100°

#### Applications

- Full color signs
- Mono color signs

## Package Dimensions

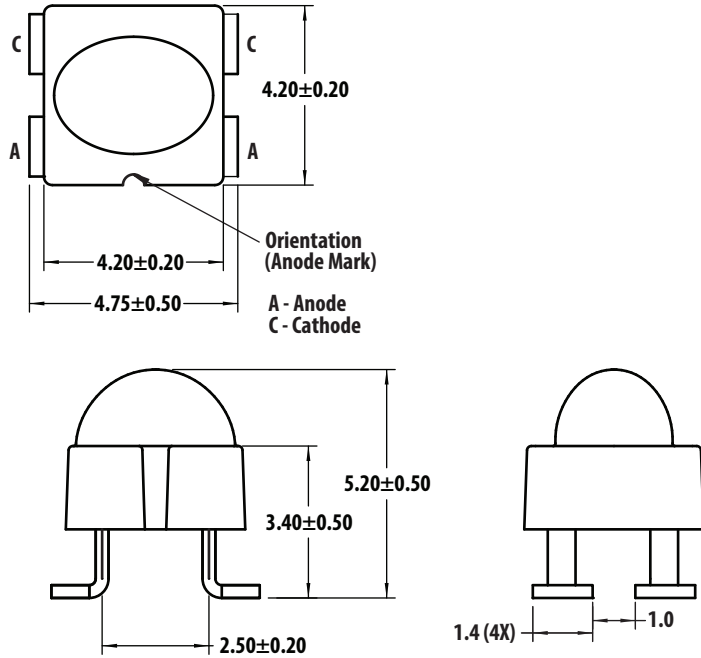

### NOTE

1. All dimensions in millimeters (inches).
2. Tolerance is  $\pm 0.20$  mm unless other specified.
3. Copper lead frame.

## Device Selection Guide

Part Number	Color and Dominant Wavelength $\lambda_d$ (nm) Typ <sup>a</sup>	Luminous Intensity $I_v$ (mcd) <sup>b, c, d</sup>		Viewing Angle Typ - ° <sup>e</sup>
		Min	Max	
ALMD-LG36-WZ002	Red 626	1380	2900	40° × 100°
ALMD-LL36-WZ002	Amber 590	1380	2900	40° × 100°
ALMD-LM36-14002	Green 525	2900	6050	40° × 100°
ALMD-LB36-SV002	Blue 470	660	1380	40° × 100°

- a. Dominant wavelength,  $\lambda_d$ , is derived from the CIE Chromaticity Diagram and represents the color of the lamp.
- b. The luminous intensity is measured on the mechanical axis of the lamp package and it is tested with pulsing condition.
- c. The optical axis is closely aligned with the package mechanical axis.
- d. Tolerance for each bin limit is  $\pm 15\%$ .
- e.  $\theta_{1/2}$  is the off-axis angle where the luminous intensity is half the on-axis intensity.

## Part Numbering System

A L M D - 

x1	x2	x3	x4
----	----	----	----

 - 

x5	x6	x7	x8	x9
----	----	----	----	----

Code	Description	Option	
x1	Package type	L	Oval AlInGaP/InGaN
x2	Color	B G L M	Blue Red Amber Green
x3x4	Viewing angle	36	40 × 100°
x5	Minimum intensity bin	Refer to device selection guide	
x6	Maximum intensity bin	Refer to device selection guide	
x7	Color bin selection	0	Full distribution
x8x9	Packaging option	02	Tested 20mA, 13inch carrier tape

## Absolute Maximum Rating, T<sub>J</sub> = 25 °C

Parameter	Red and Amber	Blue and Green	Unit
DC Forward Current <sup>a</sup>	50	30	mA
Peak Forward Current	100 <sup>b</sup>	100 <sup>c</sup>	mA
Power Dissipation	120	114	mW
Reverse Voltage	5 (I <sub>R</sub> = 100 μA) <sup>d</sup>	5 (I <sub>R</sub> = 10 μA) <sup>d</sup>	V
LED Junction Temperature	110		°C
Operating Temperature Range	-40 to +85		°C
Storage Temperature Range	-40 to +100		°C

- Derate linearly as shown in [Figure 4](#) and [Figure 9](#).
- Duty Factor 30%, frequency 1 kHz.
- Duty Factor 10%, frequency 1 kHz.
- Indicates product final testing; long-term reverse bias is not recommended.

## Electrical/Optical Characteristics, $T_J = 25\text{ }^\circ\text{C}$

Parameter	Symbol	Min.	Typ.	Max.	Units	Test Conditions
Forward Voltage Red Amber Green Blue	$V_F$	1.8 1.8 2.8 2.8	2.1 2.1 3.2 3.2	2.4 2.4 3.8 3.8	V	$I_F = 20\text{ mA}$
Reverse Voltage Red and Amber Green and Blue	$V_R$	5 5			V	$I_R = 100\text{ }\mu\text{A}$ $I_R = 10\text{ }\mu\text{A}$
Dominant Wavelength <sup>a</sup> Red Amber Green Blue	$\lambda_d$	618.0 584.5 519.0 460.0	626.0 590.0 525.0 470.0	630.0 594.5 539.0 480.0		$I_F = 20\text{ mA}$
Peak Wavelength Red Amber Green Blue	$\lambda_{PEAK}$		634 594 516 464		nm	Peak of Wavelength of Spectral Distribution at $I_F = 20\text{ mA}$
Thermal Resistance	$R_{\theta J-PIN}$		130		$^\circ\text{C/W}$	LED Junction-to-Pin
Luminous Efficacy <sup>b</sup> Red Amber Green Blue	$\eta_V$		200 520 530 65		lm/W	Emitted Luminous Power/Emitted Radiant Power
Thermal coefficient of $\lambda_d$ Red Amber Green Blue			0.059 0.103 0.028 0.024		nm/ $^\circ\text{C}$	$I_F = 20\text{ mA}; +25\text{ }^\circ\text{C} \leq T_J \leq +100\text{ }^\circ\text{C}$

- The dominant wavelength is derived from the Chromaticity Diagram and represents the color of the lamp.
- The radiant intensity,  $I_e$  in watts per steradian, may be found from the equation  $I_e = I_V/\eta_V$  where  $I_V$  is the luminous intensity in candelas and  $\eta_V$  is the luminous efficacy in lumens/watt.

# AllnGaP

Figure 1 Relative Intensity vs. Wavelength

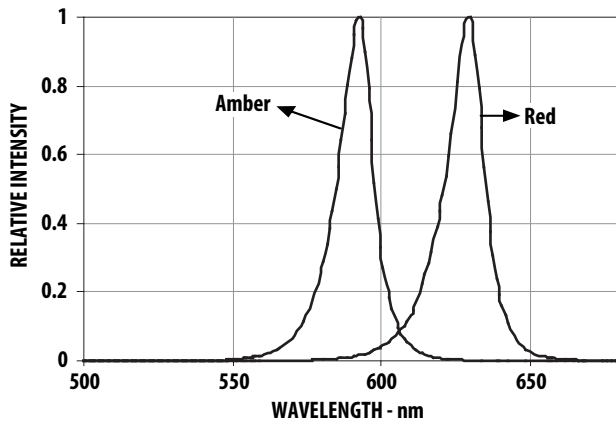

Figure 2 Forward Current vs. Forward Voltage

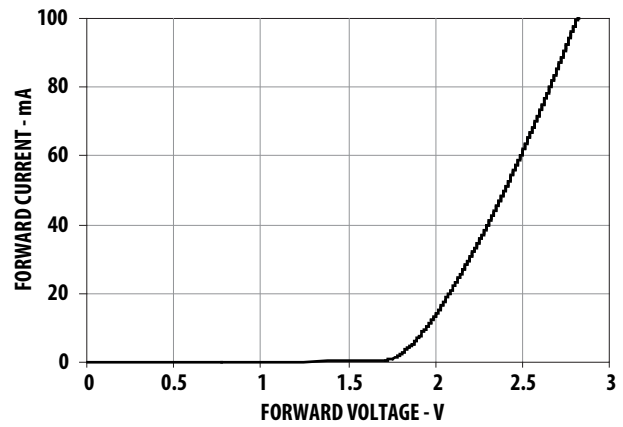

Figure 3 Relative Intensity vs. Forward Current

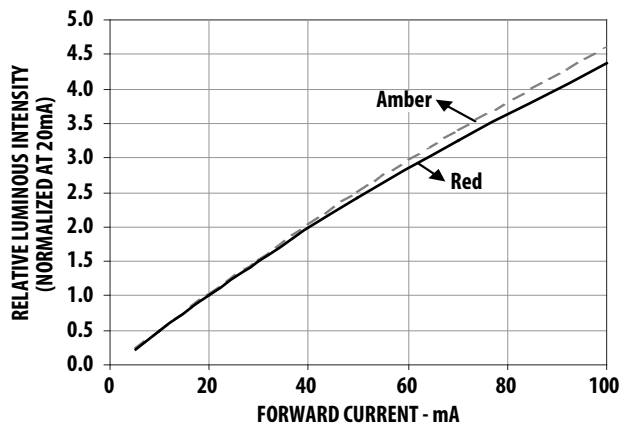
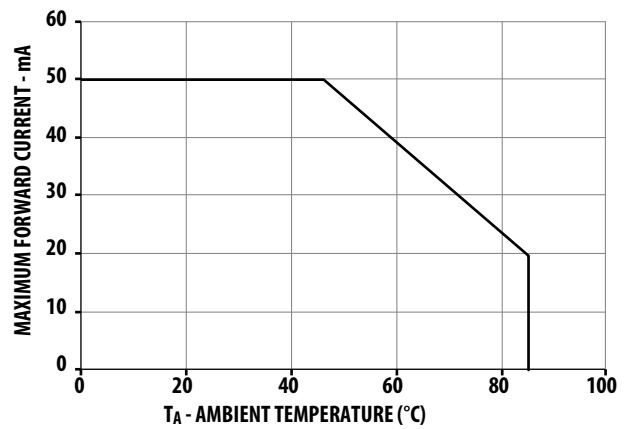
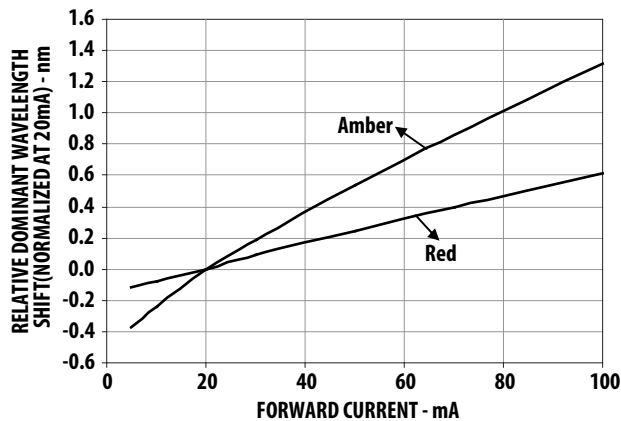

Figure 4 Maximum Forward Current vs. Ambient Temperature



NOTE  $R\theta_{J-A} = 460\text{ }^{\circ}\text{C/W}$ .

Figure 5 Relative Dominant Wavelength Shift vs. Forward Current



# InGaN

Figure 6 Relative Intensity vs. Wavelength

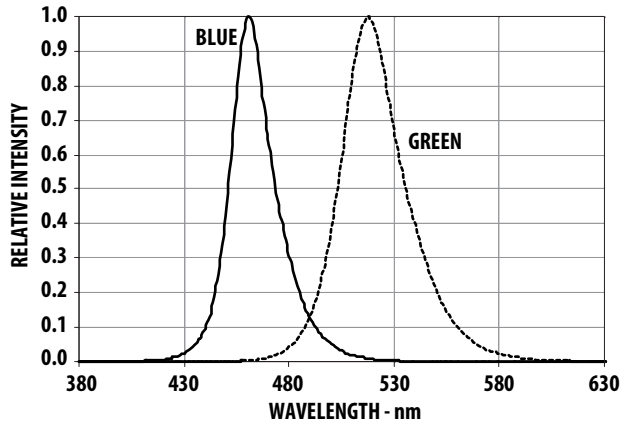

Figure 7 Forward Current vs. Forward Voltage

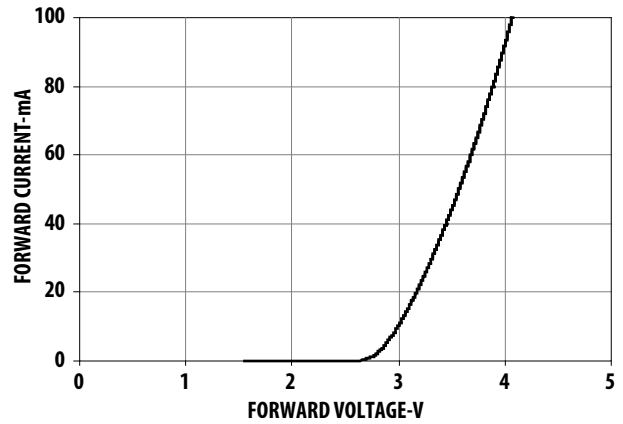

Figure 8 Relative Intensity vs. Forward Current

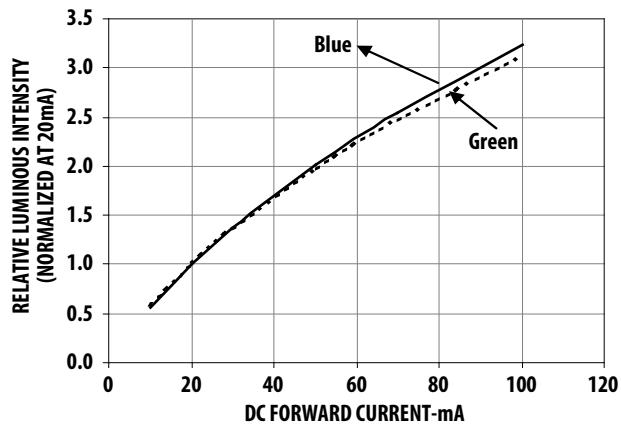

Figure 9 Maximum Forward Current vs. Ambient Temperature

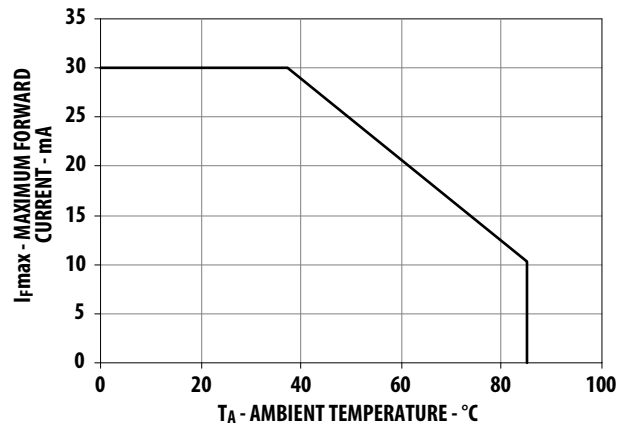
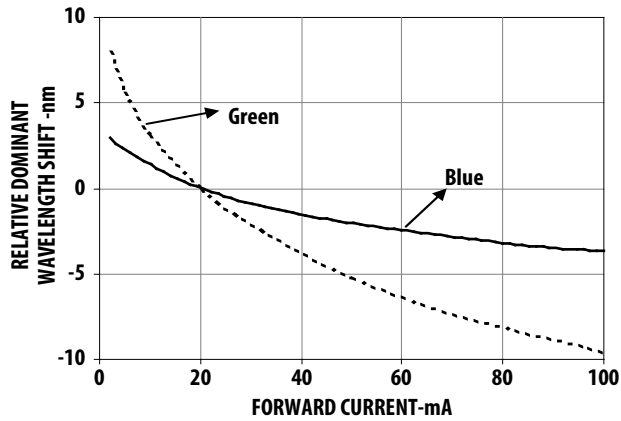
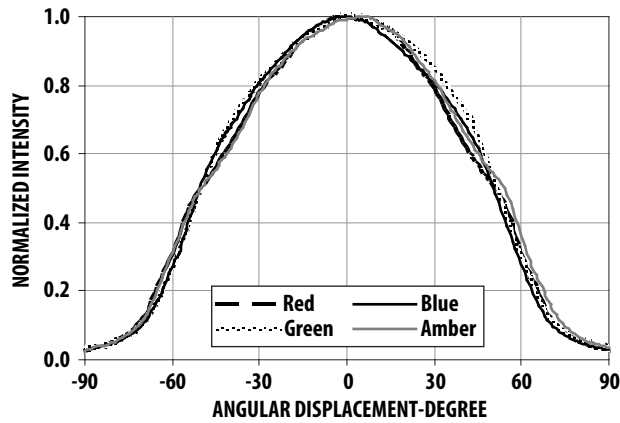

Figure 10 Dominant Wavelength Shift vs. Forward Current



**Figure 11 Radiation Pattern for Major Axis**



**Figure 12 Radiation Pattern for Minor Axis**

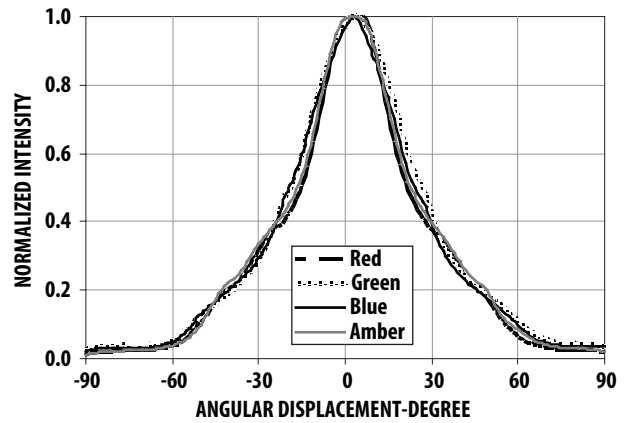

**Figure 13 Relative Intensity Shift vs. Junction Temperature**

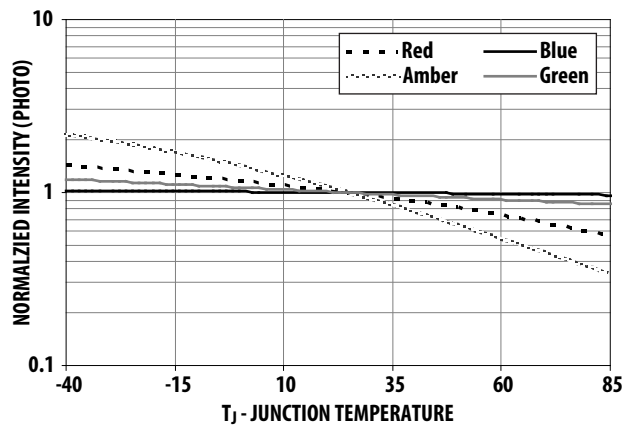

**Figure 14 Forward Voltage Shift vs. Junction Temperature**

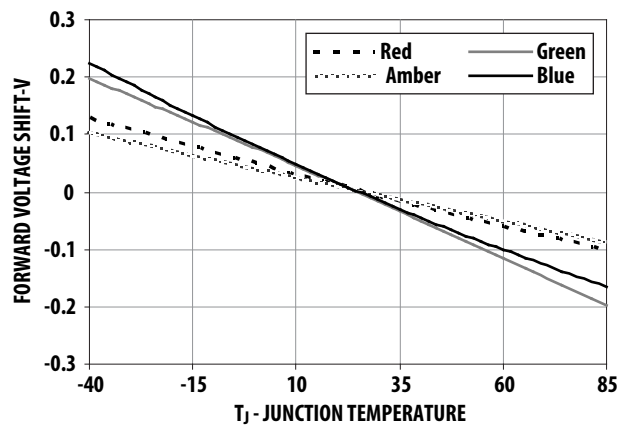

**Figure 15 Recommended Soldering Land Pattern**

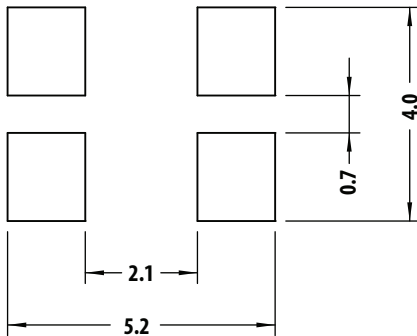

**NOTE** Recommended stencil thickness is 0.1524 mm (6 mils) minimum and above.

Figure 16 Carrier Tape Dimension

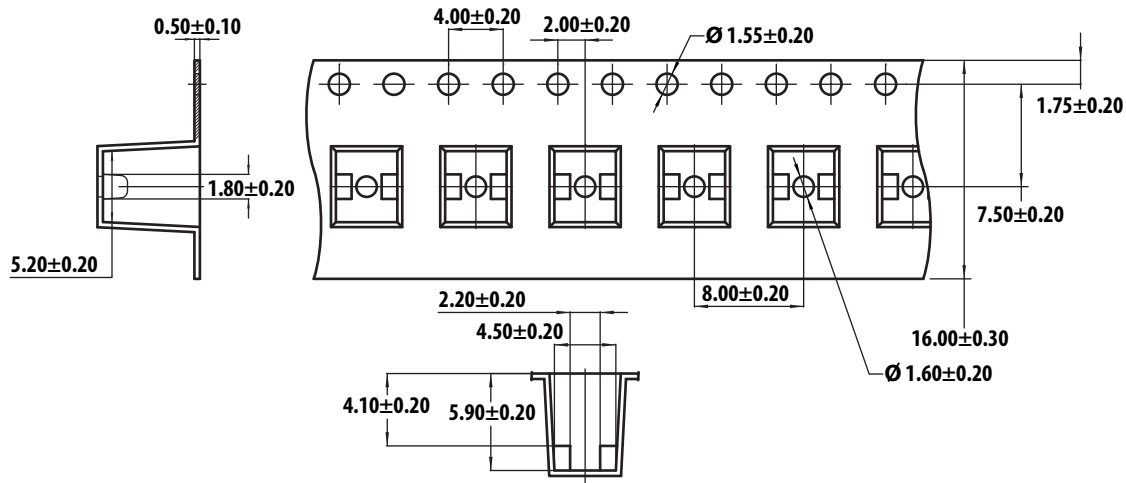
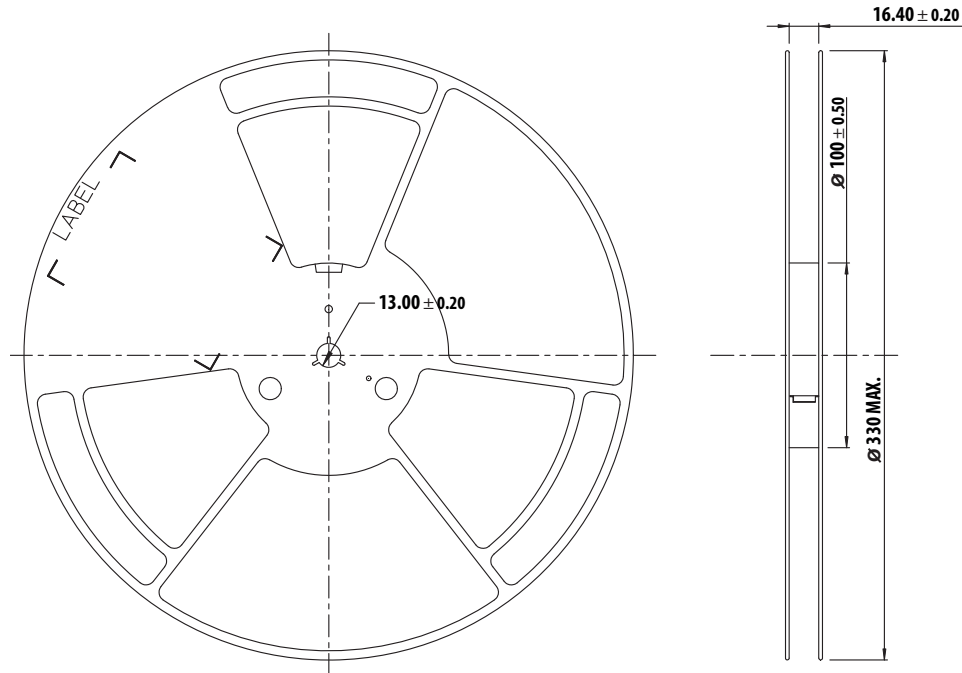
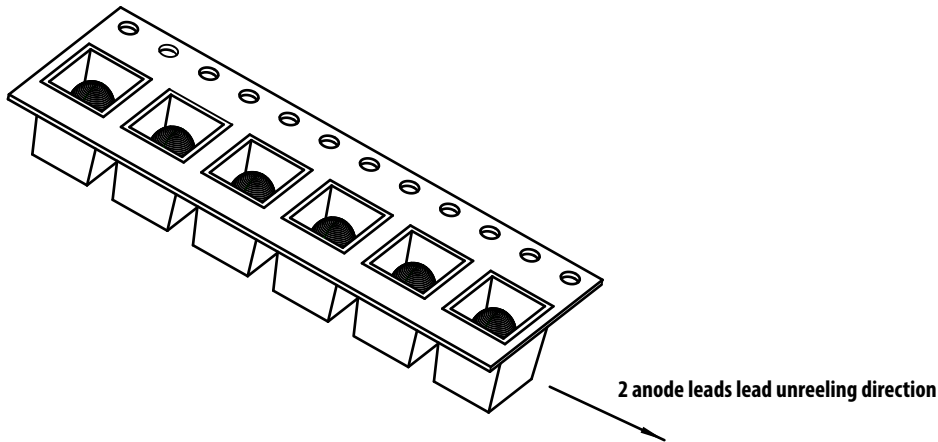

Figure 17 Reel Dimension





**Figure 18 Unit Orientation from Reel**



**Intensity Bin Limit Table (1.2:1 Iv Bin Ratio)**

Bin	Intensity (mcd) at 20 mA	
	Min	Max
S	660	800
T	800	960
U	960	1150
V	1150	1380
W	1380	1660
X	1660	1990
Y	1990	2400
Z	2400	2900
1	2900	3500
2	3500	4200
3	4200	5040
4	5040	6050

Tolerance for each bin limit is  $\pm 15\%$ .

**$V_F$  Bin Table (V at 20 mA) for Red and Amber**

Bin ID	Min	Max
$V_D$	1.8	2.0
$V_A$	2.0	2.2
$V_B$	2.2	2.4

Tolerance for each bin limit is  $\pm 0.05$  V.

## Red Color Range

Min Dom	Max Dom	X min	Y Min	X max	Y max
618.0	630.0	0.6872	0.3126	0.6890	0.2943
		0.6690	0.3149	0.7080	0.2920

Tolerance for each bin limit is  $\pm 0.5$  nm.

## Amber Color Range

Bin	Min Dom	Max Dom	Xmin	Ymin	Xmax	Ymax
1	584.5	587.0	0.5420	0.4580	0.5530	0.4400
			0.5370	0.4550	0.5570	0.4420
2	587.0	589.5	0.5570	0.4420	0.5670	0.4250
			0.5530	0.4400	0.5720	0.4270
4	589.5	592.0	0.5720	0.4270	0.5820	0.4110
			0.5670	0.4250	0.5870	0.4130
6	592.0	594.5	0.5870	0.4130	0.5950	0.3980
			0.5820	0.4110	0.6000	0.3990

Tolerance for each bin limit is  $\pm 0.5$  nm.

## Green Color Range

Bin	Min Dom	Max Dom	Xmin	Ymin	Xmax	Ymax
1	519.0	523.0	0.0667	0.8323	0.1450	0.7319
			0.1200	0.7375	0.0979	0.8316
2	523.0	527.0	0.0979	0.8316	0.1711	0.7218
			0.1450	0.7319	0.1305	0.8189
3	527.0	531.0	0.1305	0.8189	0.1967	0.7077
			0.1711	0.7218	0.1625	0.8012
4	531.0	535.0	0.1625	0.8012	0.2210	0.6920
			0.1967	0.7077	0.1929	0.7816
5	535.0	539.0	0.1929	0.7816	0.2445	0.6747
			0.2210	0.6920	0.2233	0.7600

Tolerance for each bin limit is  $\pm 0.5$  nm.













## Blue Color Range

Bin	Min Dom	Max Dom	Xmin	Ymin	Xmax	Ymax
1	460.0	464.0	0.1440	0.0297	0.1766	0.0966
			0.1818	0.0904	0.1374	0.0374
2	464.0	468.0	0.1374	0.0374	0.1699	0.1062
			0.1766	0.0966	0.1291	0.0495
3	468.0	472.0	0.1291	0.0495	0.1616	0.1209
			0.1699	0.1062	0.1187	0.0671
4	472.0	476.0	0.1187	0.0671	0.1517	0.1423
			0.1616	0.1209	0.1063	0.0945
5	476.0	480.0	0.1063	0.0945	0.1397	0.1728
			0.1517	0.1423	0.0913	0.1327









Tolerance for each bin limit is  $\pm 0.5$  nm.

## Packing Label

### (i) Mother Label (Available on MBB Bag)

	
(1P) Item: Part Number 	STANDARD LABEL LS0002
(1T) Lot: Lot Number 	RoHS Compliant
LPN: 	(Q) QTY: Quantity e4 Max Temp 260C MSL 2a 
(9D)MFG Date: Manufacturing Date 	CAT: Intensity Bin 
(P) Customer Item: 	BIN: Refer to below information 
(V) Vendor ID: 	(9D) Date Code: Date Code 
DeptID: OEAT01 	Made In: Country of Origin 

### (ii) Baby Label (Available on Plastic Reel)

	
(1P) PART #: Part Number 	BABY LABEL COSBOO1B V0.0
(1T) Lot #: Lot Number 	(Q) QTY: Quantity 
(9D)MFG Date: Manufacturing Date 	(9D) Date Code: Date Code 
C/O: Country of Origin 	CAT Intensity Bin
(1T) TAPE DATE: Taping Date 	BIN Refer to Below information

For acronyms and definitions, see the next page.

## Acronyms and Definitions

BIN:

### (i) Color bin only or V<sub>F</sub> bin only

(Applicable for part numbers with color bins but without V<sub>F</sub> bin or part numbers with V<sub>F</sub> bins and no color bin)

### (ii) Color bin incorporated with V<sub>F</sub> bin

Applicable for part numbers that have both color bin and V<sub>F</sub> bin

Example:

- a. Color bin only or V<sub>F</sub> bin only  
BIN: 4 (represent color bin 4 only)  
BIN: VA (represent V<sub>F</sub> bin "VA" only)
- b. Color bin incorporate with V<sub>F</sub> bin

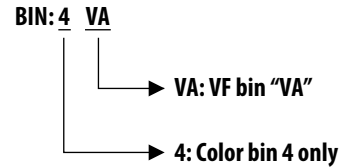

## Soldering

Recommended reflow soldering condition:

### (i) Leaded reflow soldering

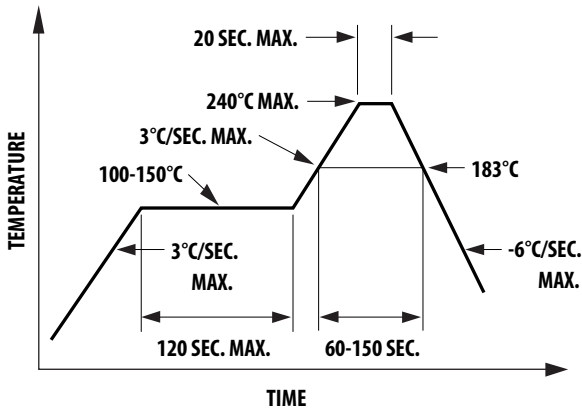

### (ii) Lead-free reflow soldering

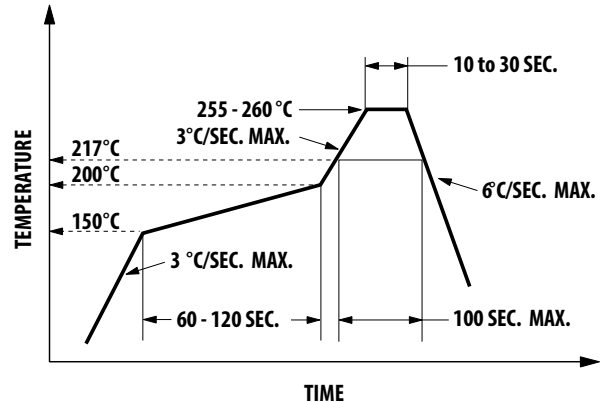

1. Reflow soldering must not be done more than two times. Make sure you take the necessary precautions for handling a moisture-sensitive device, as stated in the following section.
2. Recommended board reflow direction:

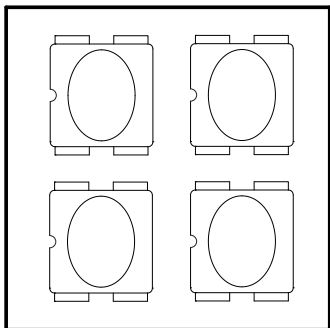

3. Do not apply any pressure or force on the LED during reflow and after reflow when the LED is still hot.
4. It is preferred that you use reflow soldering to solder the LED. Use hand soldering only for rework if unavoidable but must be strictly controlled to the following conditions:
  - Soldering iron tip temperature = 320 °C max.
  - Soldering duration = 3 sec max.
  - Number of cycles = 1 only
  - Power of soldering iron = 50 W max.
5. Do not touch the LED body with a hot soldering iron except the soldering terminals as this may damage the LED.
6. For de-soldering, it is recommended that you use a double flat tip.
7. Please confirm beforehand whether the functionality and performance of the LED is affected by hand soldering.

## Precautionary Notes

### 1. Handling precautions

For automated pick and place, Avago has tested nozzle size below made with urethane material to be working fine with this LED. However, due to the possibility of variations in other parameters such as pick and place machine maker/model and other settings of the machine, customer is recommended to verify the nozzle selected.

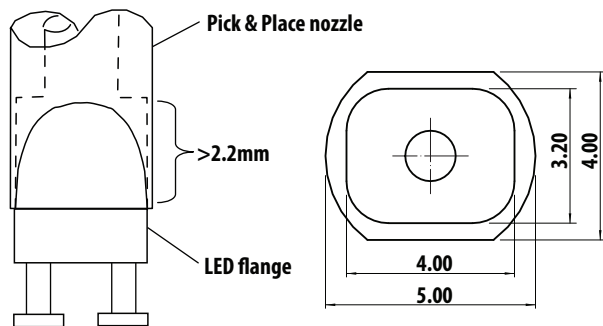

#### NOTE

- Nozzle tip should touch the LED flange during pick and place.
- Outer dimensions of the nozzle should be able to fit into the carrier tape pocket.

### 2. Handling of moisture-sensitive device

This product has a Moisture Sensitive Level 2a rating per JEDEC J-STD-020. Refer to Avago Application Note AN5305, *Handling of Moisture Sensitive Surface Mount Devices*, for additional details and a review of proper handling procedures.

- Before use
  - An unopened moisture barrier bag (MBB) can be stored at  $<40\text{ }^{\circ}\text{C}$  / 90%RH for 12 months. If the actual shelf life has exceeded 12 months and the humidity indicator card (HIC) indicates that baking is not required, then it is safe to reflow the LEDs per the original MSL rating.
  - It is recommended that the MBB not be opened prior to assembly (e.g., for IQC).
- Control after opening the MBB
  - The humidity indicator card (HIC) shall be read immediately upon opening of MBB.
  - The LEDs must be kept at  $<30\text{ }^{\circ}\text{C}$  / 60%RH at all times and all high temperature related processes including soldering, curing or rework need to be completed within 672 hours.
- Control for unfinished reel
  - Unused LEDs must be stored in a sealed MBB with desiccant or desiccator at  $<5\%$ RH.

- Control of assembled boards
  - If the PCB soldered with the LEDs is to be subjected to other high temperature processes, the PCB must be stored in sealed MBB with desiccant or desiccator at  $<5\%$ RH to ensure that all LEDs have not exceeded their floor life of 672 hours.
- Baking is required if:
  - The HIC indicator is not BROWN at 10% and is AZURE at 5%.
  - The LEDs are exposed to condition of  $>30\text{ }^{\circ}\text{C}$  / 60% RH at any time.
  - The LED floor life exceeded 672 hrs.

The recommended baking condition is:  $60\text{ }^{\circ}\text{C} \pm 5\text{ }^{\circ}\text{C}$  for 20 hrs. Baking should only be done once.

- Storage
  - The soldering terminals of these Avago LEDs are silver plated. If the LEDs are being exposed in ambient environment for too long, the silver plating might be oxidized and thus affecting its solderability performance. As such, unused LEDs must be kept in sealed MBB with desiccant or in desiccator at  $<5\%$ RH.

### 3. Application precautions

- Drive current of the LED must not exceed the maximum allowable limit across temperature as stated in the data sheet. Constant current driving is recommended to ensure consistent performance.
- LEDs do exhibit slightly different characteristics at different drive currents that might result in larger performance variations (i.e., intensity, wavelength, and forward voltage). The user is recommended to set the application current as close as possible to the test current to minimize these variations.
- The LED is not intended for reverse bias. Do use other appropriate components for such purposes. When driving the LED in matrix form, it is crucial to ensure that the reverse bias voltage does not exceed the allowable limit of the LED.
- Avoid rapid change in ambient temperature, especially in high humidity environments, because this will cause condensation on the LED.
- If the LED is intended to be used in outdoor or harsh environments, the LED leads must be protected with suitable potting material against damages caused by rain water, oil, corrosive gases, etc. It is recommended to have louver or shade to reduce direct sunlight on the LEDs.

#### 4. Eye safety precautions

LEDs may pose optical hazards when in operation. It is not advisable to view directly at operating LEDs because it may be harmful to the eyes. For safety reasons, use appropriate shielding or personal protective equipment.

**DISCLAIMER:** *Avago's products and software are not specifically designed, manufactured or authorized for sale as parts, components or assemblies for the planning, construction, maintenance or direct operation of a nuclear facility or for use in medical devices or applications. Customer is solely responsible, and waives all rights to make claims against Avago or its suppliers, for all loss, damage, expense or liability in connection with such use.*

---

For product information and a complete list of distributors, please go to our web site:

[www.avagotech.com](http://www.avagotech.com)

Avago Technologies and the A logo are trademarks of Avago Technologies in the United States and other countries. All other brand and product names may be trademarks of their respective companies.

Data subject to change. Copyright © 2014–2016 Avago Technologies. All Rights Reserved.

AV02-2377EN – April 15, 2016

**AVAGO**  
TECHNOLOGIES



Lead (Pb) Free  
RoHS 6 fully  
compliant